

# SMARTKEEPER ESSENTIAL Line-up

Lock Key Basic Line-up	베이직 키 전용 라인업	Lock Key Mini Line-up	미니용 키 전용 라인업
<ul style="list-style-type: none"> <li>USB Port Lock</li> <li>USB Cable Lock</li> <li>Keyboard/Mouse Lock</li> <li>Lockable Flash Drive</li> <li>Smart Data Blocker</li> <li>RJ45 Port Lock</li> <li>LAN Cable Lock 2</li> <li>Secure LAN Cable Coupler</li> <li>Network Module Lock 4/8/12P</li> <li>Serial Port Lock</li> <li>DVI Port Lock</li> <li>Parallel Port Lock</li> </ul>	<ul style="list-style-type: none"> <li>USB 포트락</li> <li>USB 케이블락</li> <li>키보드/마우스 락</li> <li>USB 메모리락</li> <li>USB 충전제어락</li> <li>랜포트락</li> <li>랜케이블락 2</li> <li>랜케이블 보안 커플러</li> <li>네트워크 모듈락 4/8/12P</li> <li>시리얼 포트락</li> <li>DVI 포트락</li> <li>패러렐 포트락</li> </ul>	<ul style="list-style-type: none"> <li>USB-B Port Lock</li> <li>Mini USB-B Port Lock</li> <li>Micro USB-B Port Lock</li> <li>USB-C Port Lock</li> <li>SD Port Lock</li> <li>CF Port Lock</li> <li>RJ11 Port Lock</li> <li>HDMI Port Lock</li> <li>DisplayPort Lock</li> <li>Mini DisplayPort Lock</li> </ul>	<ul style="list-style-type: none"> <li>USB-B 포트락</li> <li>Mini USB-B 포트락</li> <li>Micro USB-B 포트락</li> <li>USB-C 포트락</li> <li>SD 포트락</li> <li>CF 포트락</li> <li>RJ11 포트락</li> <li>HDMI 포트락</li> <li>Display 포트락</li> <li>Mini Display 포트락</li> </ul>

No Key Required	키 불필요 제품	All in One Security Pack	일원형 물리보안 팩
<ul style="list-style-type: none"> <li>USB Closing Lock</li> <li>LAN Cable Grip</li> <li>Power Cord Lock</li> <li>Power Extension Cord Lock</li> <li>PC Lock (Combination)</li> <li>Laptop Lock (Combination)</li> <li>Laptop Lock Plus (Combination)</li> <li>SMARTKEEPER Multi Hub</li> <li>Laptop DOCK &amp; LOCK</li> <li>Mouse Holder</li> <li>RJ45 Dust Cover</li> </ul>	<ul style="list-style-type: none"> <li>USB 폐쇄락</li> <li>랜케이블 이탈방지장치</li> <li>전원 케이블락</li> <li>전원 연장 케이블락</li> <li>PC락 (다이얼)</li> <li>노트북락 (다이얼)</li> <li>노트북락 플러스 (다이얼)</li> <li>스마트키퍼 멀티 허브</li> <li>노트북락 플러스 허브 세트</li> <li>마우스 홀더</li> <li>RJ45 먼지마개</li> </ul>	<ul style="list-style-type: none"> <li>PC Port Secure Pack</li> <li>Server Port Secure Pack</li> </ul>	<ul style="list-style-type: none"> <li>PC 포트 보안팩</li> <li>서버 포트 보안팩</li> </ul>

www.smartkeeperessential.kr  
**Made in Korea**

## Lock Key Basic

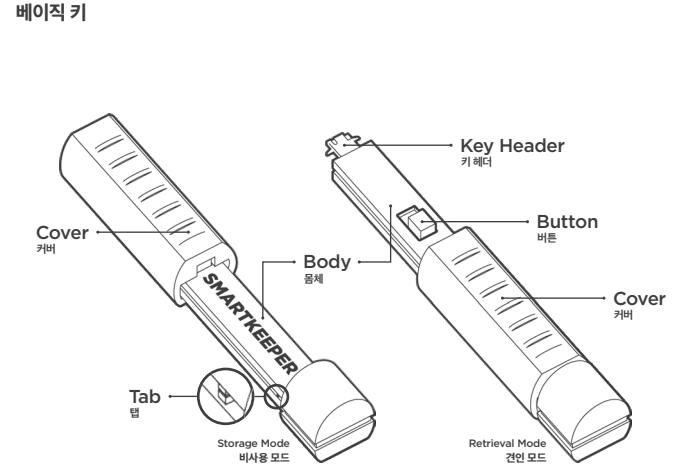

### Compatible Products with Lock Key Basic

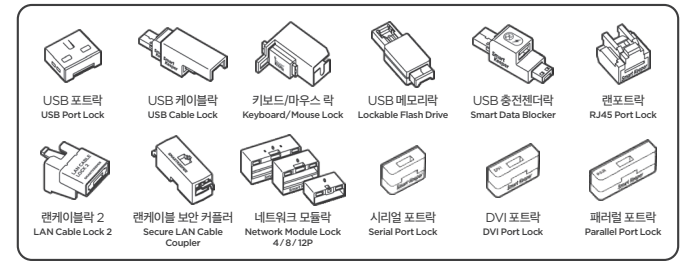

## How to use the Lock Key Basic

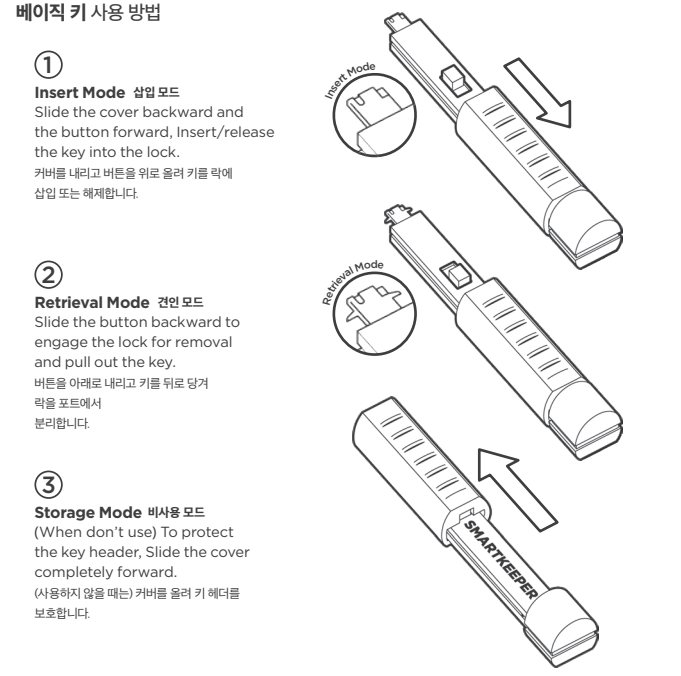

**Precautions · 주의사항**

- Make sure the key is carefully and fully engaged before removing lock.
- When sliding the cover, be careful not to pinch your hand.
- Please note that keys and locks are matched by color.
- 키는 삽입 방향이 있습니다. 방향에 유의하여 끝까지 삽입해 주세요.
- 키의 측면을 잡고 커버를 내려, 키 헤더에 손이 다치지 않도록 유의하세요.
- 포트락 / 케이블락 제품 해제시에는 동일한 색상의 키가 필요합니다.

# LAN Cable Lock 2

## User Guide

### 랜케이블락 2 사용 설명서

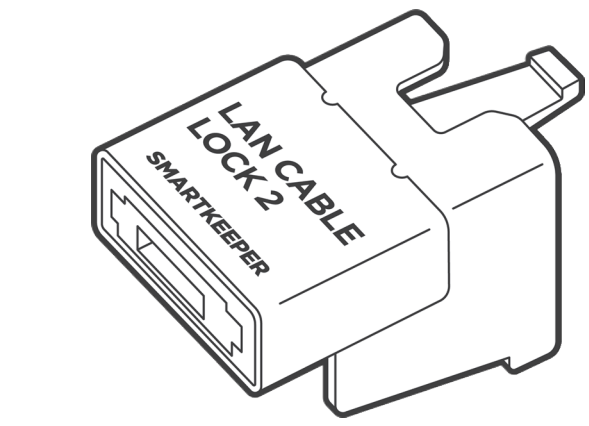

**SMARTKEEPER**  
ESSENTIAL

## LAN Cable Lock 2

Tethers LAN cable to Ethernet port to prevent unauthorized removal. Can be installed without unplugging cable in use. PC나 스위치 장비에 연결된 사용 중인 네트워크 케이블을 임의로 해제할 수 없도록 포트에 잠금하는 물리보안 제품. 사용 중인 네트워크 케이블을 해제(탈거)하지 않고도 즉시 설치 가능함.

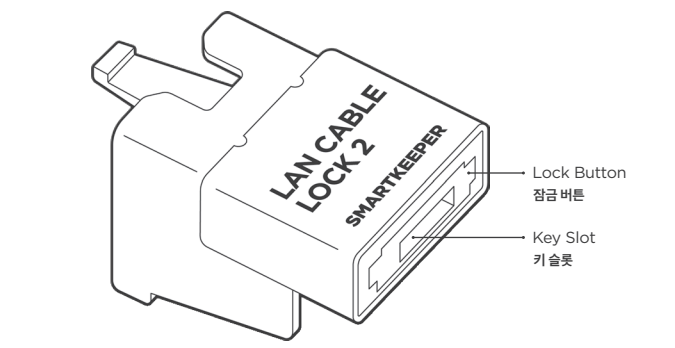
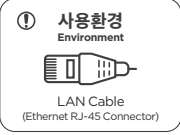

Specification	제형
랜케이블락 2 LAN Cable Lock 2	Width x Height x Length(Depth): 13.8 x 13.9 x 27.0mm (0.54 x 0.55 x 1.06in) Weight: 4.9g (0.17oz)

## Preparation for Installation - Cable boots removal

설치 준비 - 케이블 부트 제거

**Please Note**

- Due to space restrictions, it may be necessary to remove the strain relief boot.
- As illustrated below, some LAN cables are not compatible with LAN Cable Lock 2.
- 제품 설치 전, 케이블 부트(통 부트, 락부트)를 제거해야 합니다. 아래 그림과 같은 경우의 케이블에는 랜케이블락 2의 적용이 불가능합니다.

Not compatible with cables with boot cover that is not removable and larger than RJ45 connector. (락부트를 제거할 수 없고, 락부트의 크기가 앞쪽의 RJ45 커넥터 보다 두껍고 큰 완성형 케이블.)

Not compatible with LAN cables with flat cables. (케이블의 두께가 얇고 납작한 FLAT 형태의 케이블.)

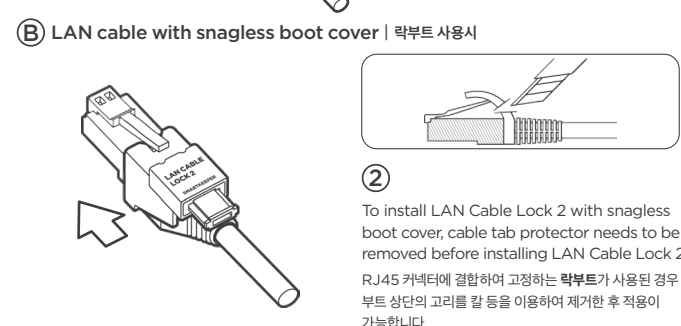
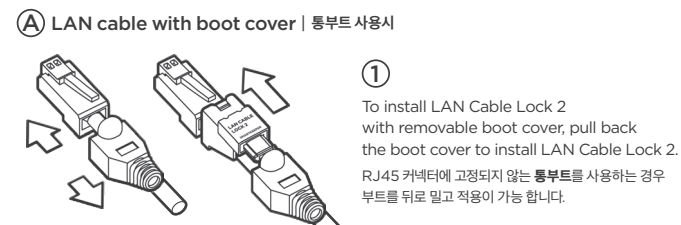

## Installation

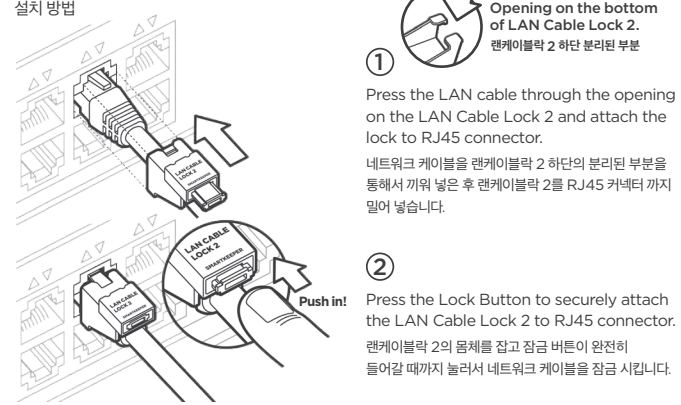

**Please Note**

- Press the lock button as LAN Cable Lock 2 is pulled out. (See diagram)
- If the lock button is not completely pressed in, LAN Cable Lock 2 is not installed properly.
- 한손으로 랜케이블락 2 몸체를 잡고 잠금 버튼을 누르는 반대 방향으로 당기면서 다른 손으로 잠금 버튼을 누르면 쉽게 잠금 버튼이 완전히 들어갑니다.
- 잠금 버튼이 완전히 들어가지 않으면, 잠금이 풀릴 수 있습니다.

## Uninstall (Removal)

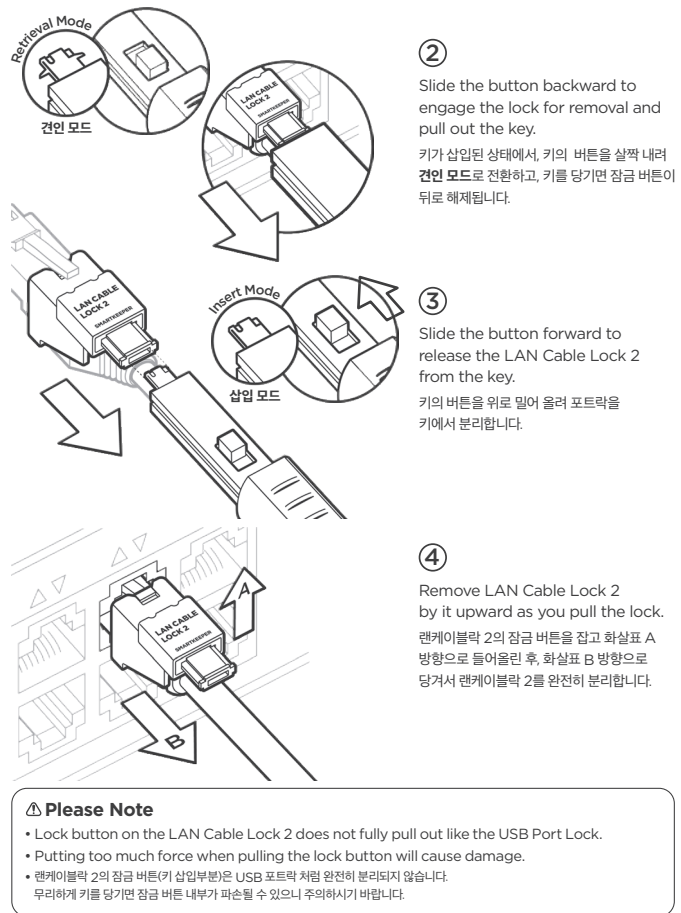
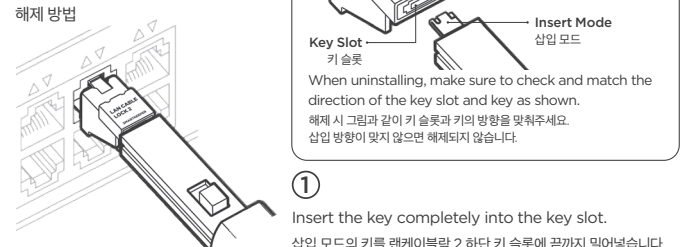

**Please Note**

- Lock button on the LAN Cable Lock 2 does not fully pull out like the USB Port Lock.
- Putting too much force when pulling the lock button will cause damage.
- 랜케이블락 2의 잠금 버튼(삽입부분)은 USB 포트락 처럼 완전히 분리되지 않습니다. 무리하게 키를 당기면 잠금 버튼 내부가 파손될 수 있으니 주의하시기 바랍니다.